

Product **Catalog**

Luxury you can afford. | Quality you can trust.



INNOVATION
C A B I N E T R Y



TABLE OF CONTENTS

Welcome	1
Diamond Difference	2
Cabinet Door Styles	6
Wall Cabinet Specifications Guide	22
Base Cabinet Specifications Guide	27
Tall Cabinet Specifications Guide	30
Accessory & Molding Specifications Guide	31
Cabinet Disclaimer	36
Cabinet Cleaning & Care	37
Policies & General	38
Warranty	39

WELCOME TO **INNOVATION CABINETRY**

What we do.

At Innovation Cabinetry, we source and market high-quality cabinets for commercial and residential use.

A family-owned, American company, we serve suppliers, contractors, builders, designers, and retailers, helping them provide their customers with quality cabinets that are beautiful and functional.

Who we are.

For over 15 years, we have been a family-owned and operated business working to provide only the highest quality cabinets with an absolute commitment to our customers.

Founded in 2005 as a retail cabinet provider in Clearwater, Florida, we grew quickly and expanded to multiple warehouse and showroom locations. We soon discovered an unmet demand in the industry - quality products, at affordable prices.

We quickly began designing creative and sustainable cabinet solutions, rooted in long-term function, and finished with style and beauty. Our products' increased demand led to establishing a central Tampa, Florida distribution warehouse and subsequent expansion into Dallas, Texas. It is from these two locations that our customer base has expanded across the entire U.S.A.

We attribute our success not only to innovative cabinet design but to the strong relationships we have forged with our customers over the years. We look forward to servicing the cabinet industry for many years to come.

TAMPA LOCATION

7030 Anderson Road

Tampa, Florida 33634

PH: 727-535-7667

Toll free: 888-206-1088

Email: info@innovationcabinetry.com

HOURS

Monday - Friday

8 a.m. - 5 p.m. (EST)

DALLAS LOCATION

11925 North Stemmons FWY, Suite 190

Dallas, Texas 75234

PH: 214-380-3660

Toll-free: 888-290-9770

Email: Dallas@innovationcabinetry.com

HOURS

Monday - Friday

8 a.m. - 5 p.m. (CST)

Diamond Difference

Style, strength, and safety are the hallmarks of our Diamond Difference. We uphold these high standards to ensure the cabinets you receive are beautiful functional, and will last a lifetime.



Sustainably Sourced Premium Wood

Each piece of every Innovation Cabinet is made from premium wood that has been legally harvested from certified forests. Sustainably sourced prime timber not only fulfills our commitment to quality materials but exemplifies our sense of responsibility to the environment. You can see the premium character in the natural, never-bleached surface of every product we create.





A **Finish** That's Complete

A performance or product is only complete once it has received that perfect finishing touch. From the faces of our cabinets to the matching interiors, every Innovation Cabinetry product receives our multi-step finishing process to ensure a beautiful, lasting surface for your home. We use the highest quality materials on the market, including Sherwin Williams, Valspar and Akzonobel paints, followed by a UV finish to prevent fading and provide superior scratch resistance.

Concern for Your **Health**

Innovation Cabinetry designs our products with homeowners in mind. While style and strength are essential, they are nothing without ensuring your safety. All of our products are CARB2 compliant, meaning they have met and exceeded the strict standards set for formaldehyde emissions. We are continually refining our production process to provide the cleanest possible products for your home.





The Sound of **Silence**

Sometimes the thing that matters the most is what's missing. With soft-close hinges and soft-close under-mount drawer glides, there won't be any slamming doors or rattling dishware. Our soft-close hardware uses natural oils to provide the effect instead of components easily broken after repeated uses. We believe that in this case you won't miss what's missing.

Impeccable **Style**, Expansive **Storage**

No matter which style of cabinet you choose, you'll be enjoying a frameless interior that provides more storage than standard framed cabinets. Drawer space is higher and deeper, and both base and wall cabinets provide 15% more storage space without the additional lip that framing requires.



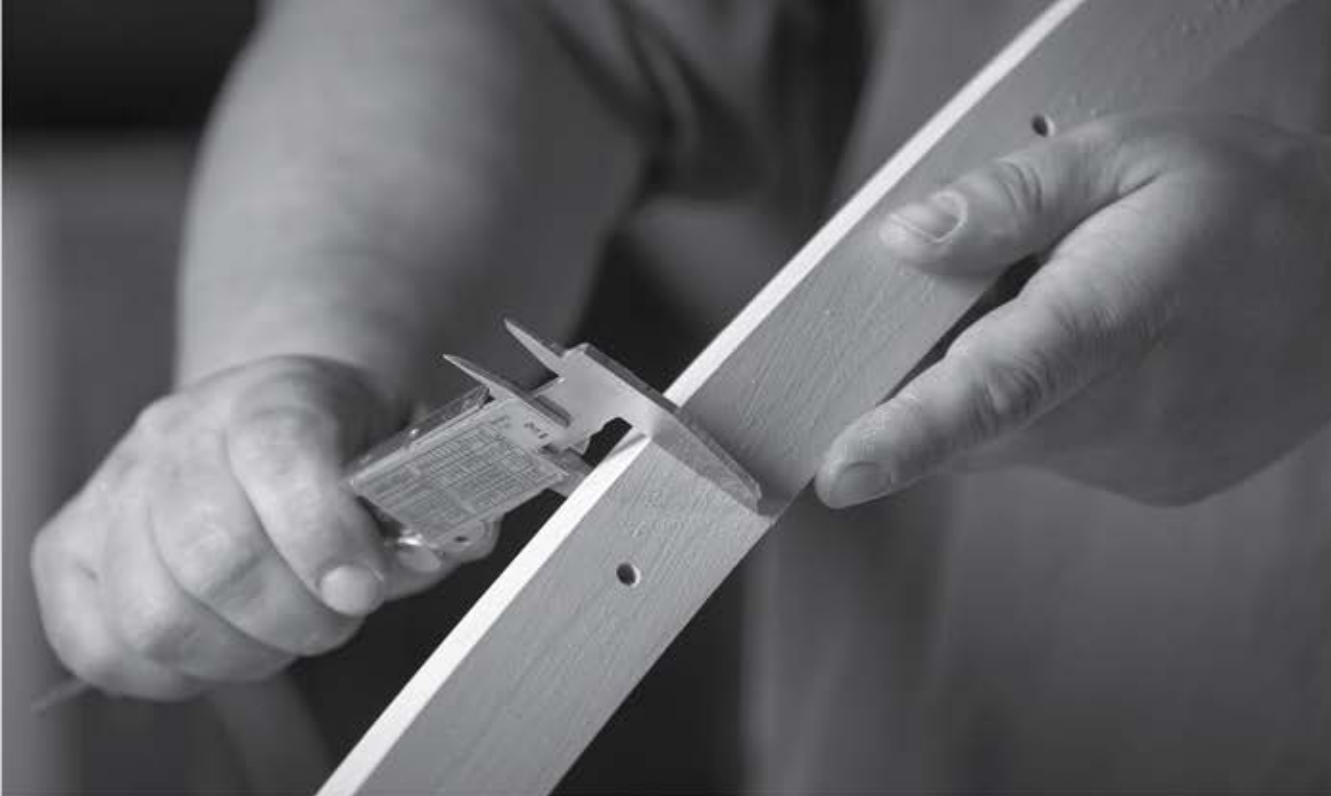

Quality Tested, Then Tested Again

Without function, form is irrelevant. The functionality of Innovation Cabinetry cabinets has been proven. And then proven again. Our soft-close glides have been tested over 50,000 times. Our 6-way adjustable hinges have been tested twice that many, the equivalent of two lifetimes of use.



Strength of Substance and Structure

Innovation Cabinetry believes in not just meeting standards but exceeding them. Our furniture-grade wood components are all 3/4", fifty percent thicker than the industry standard. We provide metal corner brackets to ensure strength and stability in all of our base cabinets. Dovetail joints, dado channels and dowels offer security between interlocking parts and are a beautiful example of the exquisite workmanship behind our cabinetry.





CLASSICALLY BEAUTIFUL, OUR VERSATILE SHAKER WHITE CABINETS PROVIDE TIMELESS LUXURY IN TRADITIONAL, TRANSITIONAL AND CONTEMPORARY STYLE HOMES. THEIR SLEEK SIMPLICITY SATISFIES EVEN THE MOST DISCERNING OF TASTES.

Shaker White

Color Code: CS

- Shaker-style frameless cabinets with minimal detailing and a low profile.
- Full overlay doors have a robust mortise and tenon construction.
- Solid wood drawers with dovetail joints.
- Soft-close doors and drawers.
- 6-way adjustable hinges.
- Concealed under-mount drawer glides with full extension.
- 3/4" furniture-grade plywood construction, 50% thicker than industry standards.
- Metal corner brackets for a stable and long-lasting foundation.
- Multi-layered painted doors with solid wood frames and flat recessed MDF center panels.
- Matching interior and exterior finish for a flawless look.
- Offered with a glass front option (glass and clips not included).
- Decorative trim and molding available.

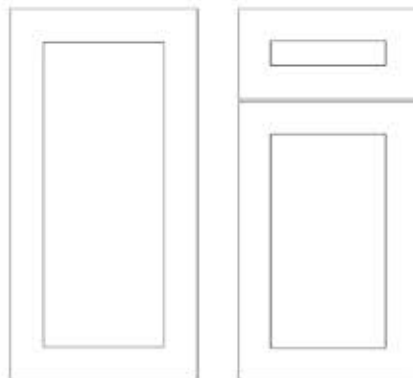

CABINET DOOR STYLES CRAFTSMAN COLLECTION

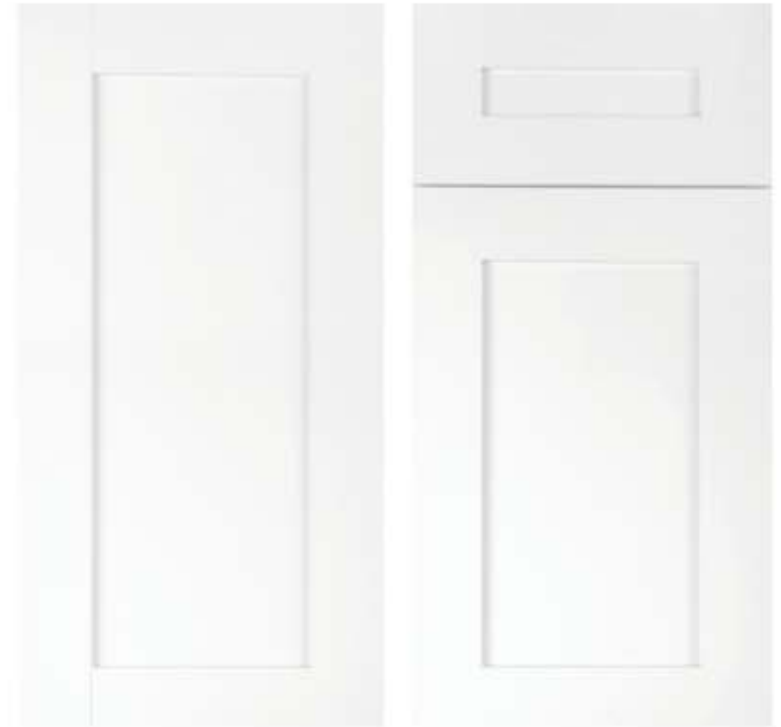

DECORATIVE MOLDING

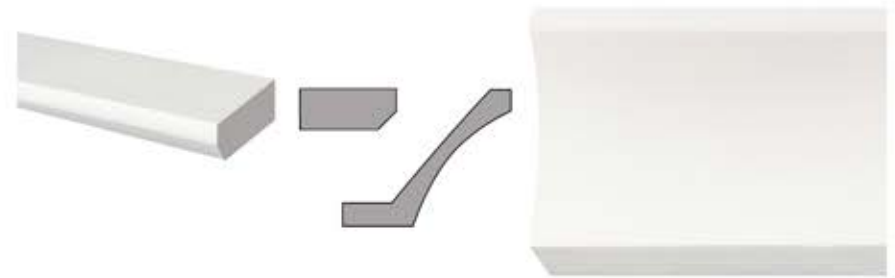

CABINET DOOR STYLES CRAFTSMAN COLLECTION



DECORATIVE MOLDING

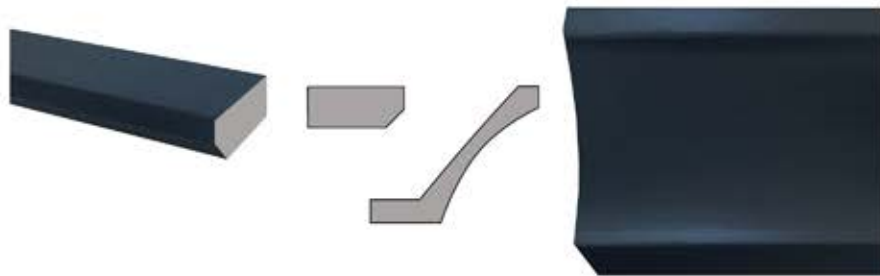

Imperial Blue

Color Code: CB

- Shaker-style frameless cabinets with minimal detailing and a low profile.
- Full overlay doors have a robust mortise and tenon construction.
- Solid wood drawers with dovetail joints.
- Soft-close doors and drawers.
- 6-way adjustable hinges.
- Concealed under-mount drawer glides with full extension.
- 3/4" furniture-grade plywood construction, 50% thicker than industry standards.
- Metal corner brackets for a stable and long-lasting foundation.
- Multi-layered painted doors with solid wood frames and flat recessed MDF center panels.
- Matching interior and exterior finish for a flawless look.
- Offered with a glass front option (glass and clips not included).
- Decorative trim and molding included.

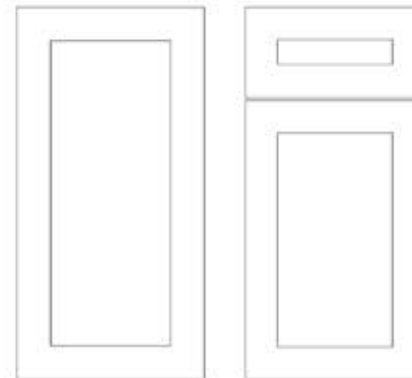



ELEVATE THE ELEGANCE IN YOUR HOME WITH IMPERIAL BLUE CABINETS. STRIKING AND STYLISH WITH SIMPLE LINES THAT ALLOW THE DYNAMIC COLOR TO TAKE CENTER STAGE, BRINGING IMPACT AND INSPIRATION TO ANY ROOM OF THE HOME.



WE'VE TAKEN WHITE TO A SUMPTUOUS NEW LEVEL WITH THIS LUSTROUS COLOR AND CLEAN, CONTEMPORARY LINES. OUR PEARL WHITE CABINETS EMBODY CLASSIC, UNDERSTATED ELEGANCE WITH MODERN SOPHISTICATION.

Pearl White

Color Code: CP

- Shaker-style frameless cabinets with minimal detailing and a low profile.
- Full overlay doors have a robust mortise and tenon construction.
- Solid wood drawers with dovetail joints.
- Soft-close doors and drawers.
- 6-way adjustable hinges.
- Concealed under-mount drawer glides with full extension.
- 3/4" furniture-grade plywood construction, 50% thicker than industry standards.
- Metal corner brackets for a stable and long-lasting foundation.
- Multi-layered painted doors with solid wood frames and flat recessed MDF center panels.
- Matching interior and exterior finish for a flawless look.
- Offered with a glass front option (glass and clips not included).
- Decorative trim and molding available.

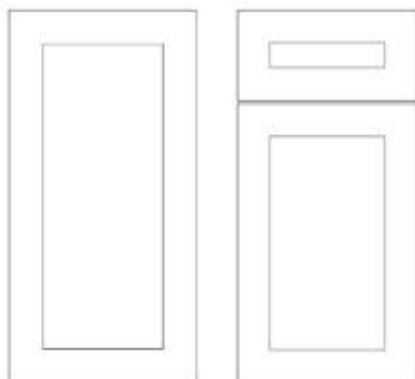

CABINET DOOR STYLES CRAFTSMAN COLLECTION



DECORATIVE MOLDING



CABINET DOOR STYLES CRAFTSMAN COLLECTION



DECORATIVE MOLDING

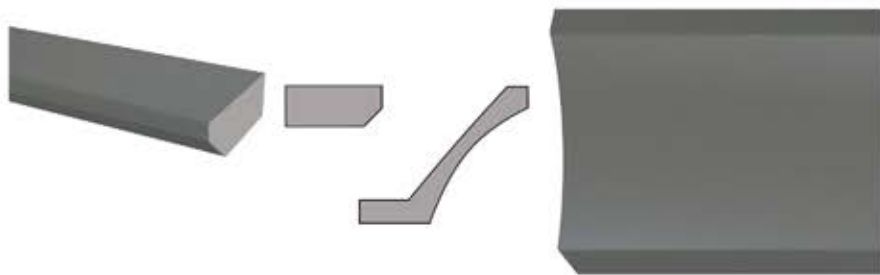

Storm Gray

Color Code: CG

- Shaker-style frameless cabinets with minimal detailing and a low profile.
- Full overlay doors have a robust mortise and tenon construction.
- Solid wood drawers with dovetail joints.
- Soft-close doors and drawers.
- 6-way adjustable hinges.
- Concealed under-mount drawer glides with full extension.
- 3/4" furniture-grade plywood construction, 50% thicker than industry standards.
- Metal corner brackets for a stable and long-lasting foundation.
- Multi-layered painted doors with solid wood frames and flat recessed MDF center panels.
- Matching interior and exterior finish for a flawless look.
- Offered with a glass front option (glass and clips not included).
- Decorative trim and molding available.

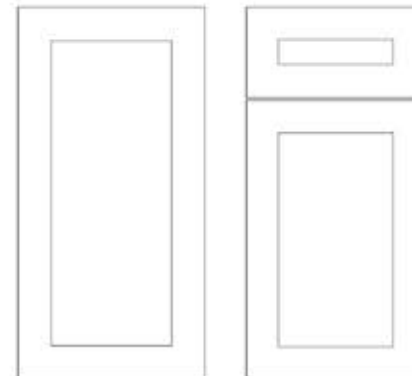



SLEEK AND CLEAN, STORM GRAY CABINETS CREATE A LOOK THAT EPITOMIZES THE MODERN KITCHEN. THE STREAMLINE DESIGN AND SOOTHING COLOR CREATE A COOL URBAN VIBE.



A TIMELESS CHOCOLATE PALETTE MAKES MIDNIGHT ESPRESSO BOTH ELEGANT AND REFINED. AT HOME IN BOTH A MODERN OR FARMHOUSE KITCHEN, THE UNADORNED SURFACE ALLOWS THE SUMPTUOUS AND STRIKING WOOD-STAINED FINISH TO SPEAK.

Midnight Espresso

Color Code: CO

- Shaker-style frameless cabinets with minimal detailing and a low profile.
- Full overlay doors have a robust mortise and tenon construction.
- Solid wood drawers with dovetail joints.
- Soft-close doors and drawers.
- 6-way adjustable hinges.
- Concealed under-mount drawer glides with full extension.
- 3/4" furniture-grade plywood construction, 50% thicker than industry standards.
- Metal corner brackets for a stable and long-lasting foundation.
- Multi-layered painted doors with solid wood frames and flat recessed MDF center panels.
- Matching interior and exterior finish for a flawless look.
- Offered with a glass front option (glass and clips not included).
- Decorative trim and molding available.

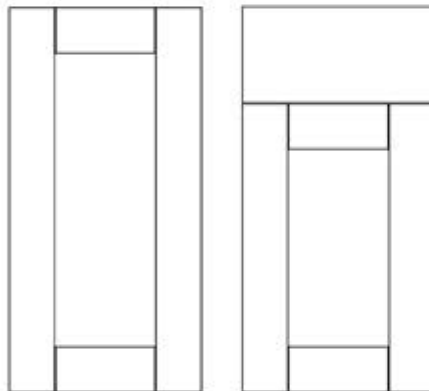

CABINET DOOR STYLES CRAFTSMAN COLLECTION



DECORATIVE MOLDING

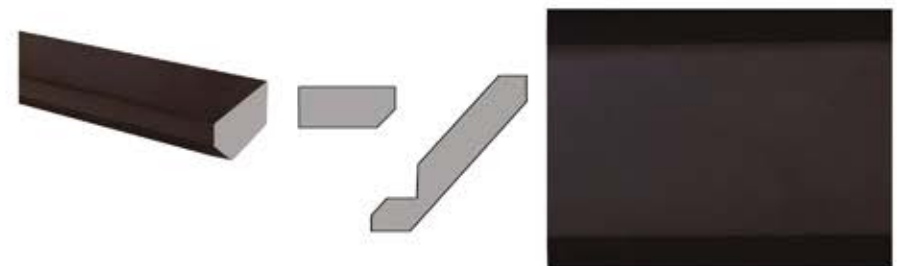

CABINET DOOR STYLES CLASSIC COLLECTION



DECORATIVE MOLDING

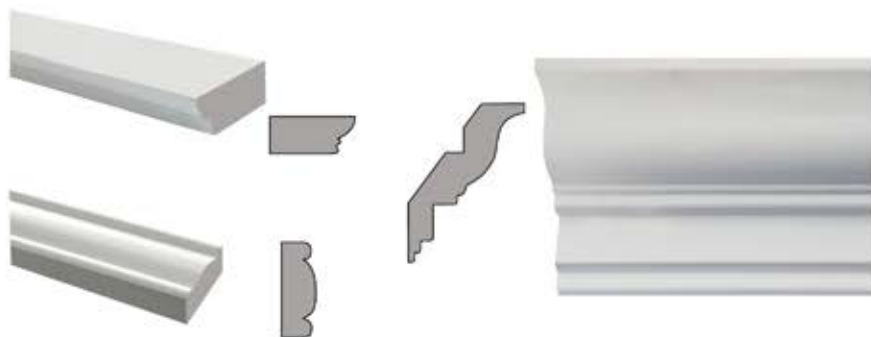

Classic White

Color Code: CW

- Frameless cabinet with raised panel doors for classical styling.
- Full overlay doors have a robust mortise and tenon construction.
- Solid wood drawers with dovetail joints.
- Soft-close doors and drawers.
- 6-way adjustable hinges.
- 3/4" furniture-grade plywood construction, 50% thicker than industry standards.
- Concealed under-mount drawer glides with full extension.
- Metal corner brackets for a stable and long-lasting foundation.
- Multi-layered painted doors with solid wood frames and decorative raised MDF center panel.
- Matching interior and exterior finish for a flawless look.
- Offered with a glass front option (glass and clips not included).
- Decorative trims, molding, and embellishments available.

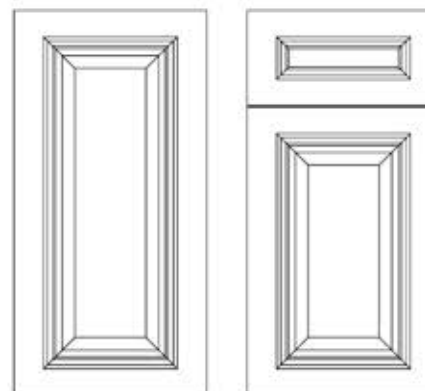



CLASSIC WHITE IS ALWAYS PRACTICAL, STYLISH, AND FUNCTIONAL. THIS COOL WHITE CABINETY WILL DAZZLE ANY KITCHEN, BATHROOM OR PERSONAL LIBRARY WITH ITS CORRECT FORM AND INTRICATE RAISED DOOR DETAIL.



MADURO CABINETS HONOR A GRACEFUL, CLASSIC AND DISTINCTLY AMERICAN STYLE. THE NUTMEG HUE WILL NO DOUBT OFFER INSPIRATION IN ANY LUXURY KITCHEN.

Maduro

Color Code: CR

- Frameless cabinets with raised panel doors for classical styling.
- Full overlay doors has a robust mortise and tenon construction.
- Solid wood drawers with dovetail joints.
- Soft-close doors and drawers.
- 6-way adjustable hinges.
- 3/4" furniture-grade plywood construction, 50% thicker than industry standards.
- Concealed under-mount drawer glides with full extension.
- Metal corner brackets for a stable and long-lasting foundation.
- Multi-layered stained doors with solid wood frames and decorative solid wood center panels.
- Matching interior and exterior finish for a flawless look.
- Offered with a glass front option (glass and clips not included).
- Decorative trims, molding, and embellishments available.

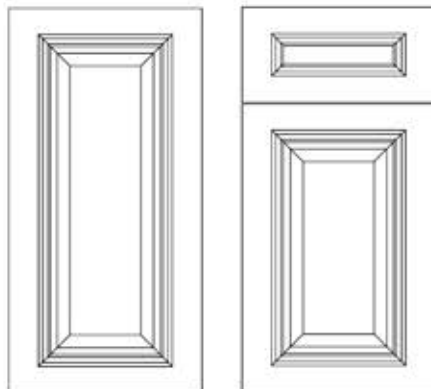

CABINET DOOR STYLES CLASSIC COLLECTION



DECORATIVE MOLDING

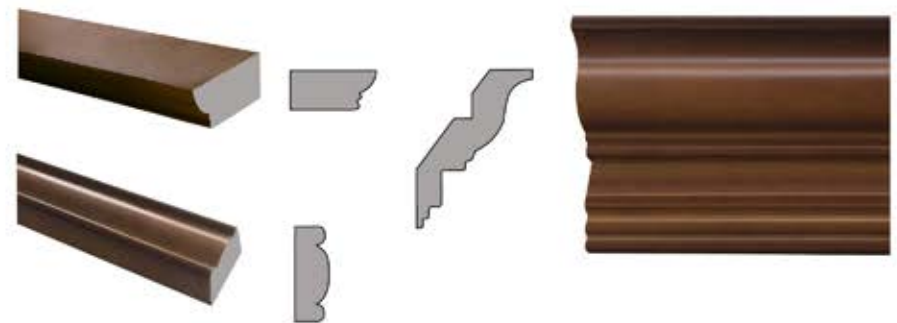

CABINET DOOR STYLES CLASSIC COLLECTION



DECORATIVE MOLDING



Coastal Cream

Color Code: CC

- Frameless cabinets with raised panel doors for classical styling.
- Full overlay doors have a robust mortise and tenon construction.
- Solid wood drawers with dovetail joints.
- Soft-close doors and drawers.
- 6-way adjustable hinges.
- 3/4" furniture-grade plywood construction, 50% thicker than industry standards.
- Concealed under-mount drawer glides with full extension.
- Metal corner brackets for a stable and long-lasting foundation.
- Multi-layered painted doors with solid wood frames and decorative raised MDF center panels.
- Matching interior and exterior finish for a flawless look.
- Offered with a glass front option (glass and clips not included).
- Decorative trims, molding, and embellishments available.

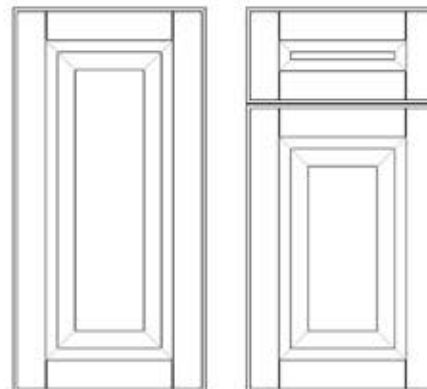





TIMELESS FEATURES, DECORATIVE ACCENTS, AND NEUTRAL COLOR PALETTE ENSURE A LOOK THAT SUITS A WIDE VARIETY OF TASTES AND STYLES; COASTAL CREAM BRINGS ENDURING APPEAL AND WARMTH TO THE HOME.

WALL CABINET SPECIFICATIONS GUIDE

WALL CABINET 30" TALL	CODE	W X H X D	AVAILABLE IN ALL STYLES
	W0930	09x30x12	
	W1230	12x30x12	
	W1530	15x30x12	
	W1830	18x30x12	
	W2130	21x30x12	

WALL CABINET 30" TALL	CODE	W X H X D	AVAILABLE IN ALL STYLES
	W2430	24x30x12	
	W2730	27x30x12	
	W3030	30x30x12	
	W3330	33x30x12	
	W3630	36x30x12	

WALL CABINET 36" TALL	CODE	W X H X D	AVAILABLE IN ALL STYLES
	W0936	09x36x12	
	W1236	12x36x12	
	W1536	15x36x12	
	W1836	18x36x12	
	W2136	21x36x12	

WALL CABINET 36" TALL	CODE	W X H X D	AVAILABLE IN ALL STYLES
	W2436	24x36x12	
	W2736	27x36x12	
	W3036	30x36x12	
	W3336	33x36x12	
	W3636	36x36x12	

WALL CABINET 42" TALL	CODE	W X H X D	AVAILABLE IN ALL STYLES
	W0942	09x42x12	
	W1242	12x42x12	
	W1542	15x42x12	
	W1842	18x42x12	
	W2142	21x42x12	

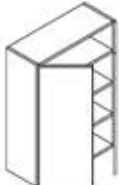
WALL CABINET 42" TALL	CODE	W X H X D	AVAILABLE IN ALL STYLES
	W2442	24x42x12	
	W2742	27x42x12	
	W3042	30x42x12	
	W3342	33x42x12	
	W3642	36x42x12	

WALL CABINET SPECIFICATIONS GUIDE

WALL CABINET 30" WIDE

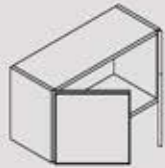

CODE	W X H X D	AVAILABLE IN ALL STYLES
W3012	30x12x12	
W3015	30x15x12	
W3018	30x18x12	
W3021	30x21x12	

WALL CABINET 24" DEEP

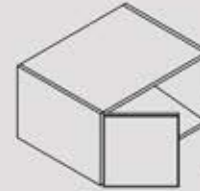

CODE	W X H X D	AVAILABLE IN ALL STYLES
W3012-24	30x12x24	
W3018-24	30x18x24	
W3612-24	36x12x24	
W3615-24	36x15x24	
W3618-24	36x18x24	
W3621-24	36x21x24	

WALL CABINET 36" WIDE

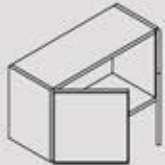

CODE	W X H X D	AVAILABLE IN ALL STYLES
W3612	36x12x12	
W3615	36x15x12	
W3618	36x18x12	
W3621	36x21x12	

WALL CABINET 24" DEEP



CODE	W X H X D	AVAILABLE IN ALL STYLES *Dallas only.
W2412-24	24X12X24	
W2412-24*	24X12X24	

WALL CABINET 24" TALL



CODE	W X H X D	W2424 AVAILABLE IN • CLASSIC WHITE • IMPERIAL BLUE • PEARL WHITE • SHAKER WHITE • STORM GRAY
W2424	24x24x12	
W3024	30x24x12	
W3624	36x24x12	

WALL CABINET 24" WIDE



CODE	W X H X D	AVAILABLE IN • CLASSIC WHITE • IMPERIAL BLUE • PEARL WHITE • SHAKER WHITE • STORM GRAY
W2412	24x12x12	
W2418	24x18x12	

WALL CABINET SPECIFICATIONS GUIDE

WALL MULLION DOOR 30" TALL	CODE	W X H X D	
	WMD1230	12x30x12	AVAILABLE IN ALL STYLES *Coastal Cream Note: All WMD cabinets are sold as a kit containing a standard wall cabinet and a separate door that will accommodate glass. Glass and clips, not included.
	WMD1530	15x30x12	
	WMD1830	18x30x12	
	WMD2130*	21x30x12	

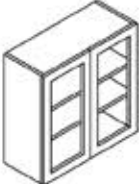
WALL MULLION DOOR 30" TALL	CODE	W X H X D	
	WMD2430	24x30x12	AVAILABLE IN ALL STYLES *Coastal Cream Note: All WMD cabinets are sold as a kit containing a standard wall cabinet and a separate door that will accommodate glass. Glass and clips, not included.
	WMD2730*	27x30x12	
	WMD3030	30x30x12	
	WMD3330*	33x30x12	
	WMD3630	36x30x12	

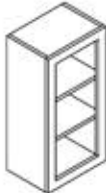
WALL MULLION DOOR 36" TALL	CODE	W X H X D	
	WMD1236	12x36x12	AVAILABLE IN ALL STYLES *Coastal Cream Note: All WMD cabinets are sold as a kit containing a standard wall cabinet and a separate door that will accommodate glass. Glass and clips, not included.
	WMD1536	15x36x12	
	WMD1836	18x36x12	
	WMD2136*	21x36x12	

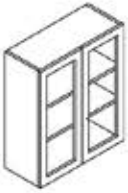
WALL MULLION DOOR 36" TALL	CODE	W X H X D	
	WMD2436	24x36x12	AVAILABLE IN ALL STYLES *Coastal Cream Note: All WMD cabinets are sold as a kit containing a standard wall cabinet and a separate door that will accommodate glass. Glass and clips, not included.
	WMD2736*	27x36x12	
	WMD3036	30x36x12	
	WMD3336*	33x36x12	
	WMD3636	36x36x12	

WALL MULLION DOOR 42" TALL	CODE	W X H X D	
	WMD1242	12x42x12	AVAILABLE IN ALL STYLES *Coastal Cream Note: All WMD cabinets are sold as a kit containing a standard wall cabinet and a separate door that will accommodate glass. Glass and clips, not included.
	WMD1542	15x42x12	
	WMD1842	18x42x12	
	WMD2142*	21x42x12	

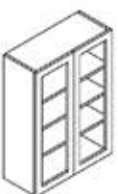
WALL MULLION DOOR 42" TALL	CODE	W X H X D	
	WMD2442	24x42x12	AVAILABLE IN ALL STYLES *Coastal Cream Note: All WMD cabinets are sold as a kit containing a standard wall cabinet and a separate door that will accommodate glass. Glass and clips, not included.
	WMD2742*	27x42x12	
	WMD3042	30x42x12	
	WMD3342*	33x42x12	
	WMD3642	36x42x12	

WALL CABINET SPECIFICATIONS GUIDE

WALL DIAGONAL MILLION DOOR

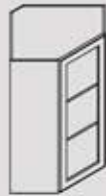

CODE	W × H × D
WDCMD2430	24x30x12
WDCMD2436	24x36x12
WDCMD2442*	24x42x12

AVAILABLE IN ALL STYLES

*WDCMD2442 constructed with 3 shelves.

Note: All WDCMD cabinets are sold as a kit containing a standard wall cabinet and a separate door that will accommodate glass. Glass and clips, not included.

WALL OPEN END SHELF 12" WIDE



CODE	W × H × D
WOES1230	12x30x12
WOES1236	12x36x12
WOES1242*	12x42x12

AVAILABLE IN ALL STYLES

*WOES1242 constructed with 3 shelves.

WALL DIAGONAL CABINET



CODE	W × H × D
WDC2430	24x30x12
WDC2436	24x36x12
WDC2442*	24x42x12

AVAILABLE IN ALL STYLES

*WDC2442 constructed with 3 shelves.

WALL OPEN END SHELF 6" WIDE



CODE	W × H × D
WOES0630	06x30x12
WOES0636	06x36x12
WOES0642*	06x42x12

AVAILABLE IN ALL STYLES

*WOES0642 constructed with 3 shelves.

WALL END ANGLE CABINET



CODE	W × H × D
WEA1230	12x30x12
WEA1236	12x36x12
WEA1242	12x42x12

AVAILABLE IN ALL STYLES

WALL CABINET SPECIFICATIONS GUIDE

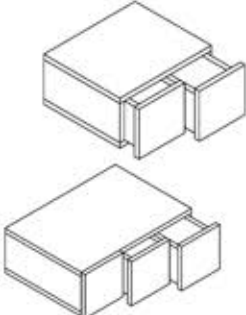
WALL SMALL DRAWER CABINET	CODE	W X H X D	
	WSD1206-2	12x06x12	AVAILABLE IN ALL STYLES Note: Fitted drawers do not require nor include glides.
	WSD1806-3	18x06x12	

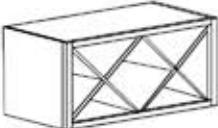
WINE RACK X-STYLE	CODE	W X H X D	
	WSC3018	30x18x12	AVAILABLE IN ALL STYLES
	WSC3618	36x18x12	

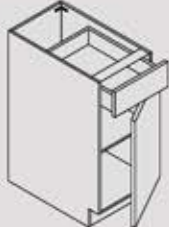

BASE CABINET SPECIFICATIONS GUIDE

BASE CABINET	CODE	W × H × D	AVAILABLE IN ALL STYLES
	B09	09x34.5x24	
	B12	12x34.5x24	
	B15	15x34.5x24	
	B18	18x34.5x24	
	B21	21x34.5x24	

SINK BASE CABINET	CODE	W × H × D	AVAILABLE IN ALL STYLES
	SB24	24x34.5x24	
	SB27	27x34.5x24	
	SB30	30x34.5x24	
	SB33	33x34.5x24	
	SB36	36x34.5x24	
	SB39	39x34.5x24	
	SB42	42x34.5x24	

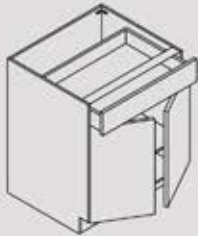
BASE CABINET	CODE	W × H × D	AVAILABLE IN ALL STYLES
	B24	24x34.5x24	
	B27	27x34.5x24	
	B30	30x34.5x24	
	B33	33x34.5x24	
	B36	36x34.5x24	
	B39	39x34.5x24	
	B42	42x34.5x24	

DRAWER BASE CABINET	CODE	W × H × D	AVAILABLE IN ALL STYLES
	DB12-3	12x34.5x24	
	DB15-3	15x34.5x24	
	DB18-3	18x34.5x24	
	DB21-3	21x34.5x24	
	DB24-3	24x34.5x24	
	DB27-3	27x34.5x24	
	DB30-3	30x34.5x24	
	DB33-3	33x34.5x24	
	DB36-3	36x34.5x24	

BASE CABINET SPECIFICATIONS GUIDE

BASE SPICE RACK CABINET	CODE	W × H × D	
	BSR09	09x34.5x24	AVAILABLE IN ALL STYLES

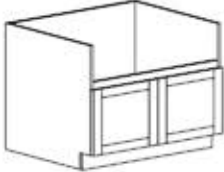
FARM SINK BASE	CODE	W × H × D	
	FSB30	30x34.5x24	AVAILABLE IN • CLASSIC WHITE • IMPERIAL BLUE • PEARL WHITE • SHAKER WHITE • STORM GRAY
	FSB33	33x34.5x24	
	FSB36	36x34.5x24	

BASE DIAGONAL CABINET	CODE	W × H × D	
	BDC36	36x34.5x24	AVAILABLE IN ALL STYLES Note: The BDC36 cabinet may also be used as a corner sink base cabinet with the shelf removed.

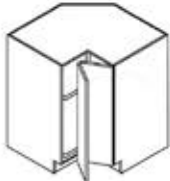
BASE LAZY SUSAN CABINET	CODE	W × H × D	
	BLS33	33x34.5x24	AVAILABLE IN ALL STYLES Note: Includes metal lazy susan insert.
	BLS36	36x34.5x24	

BASE BLIND CORNER CABINET	CODE	W × H × D	
	BBC39	39x34.5x24	AVAILABLE IN ALL STYLES Note: Requires return filler.
	BBC42	42x34.5x24	
	BBC45	45x34.5x24	

BASE END OPEN SHELF	CODE	W × H × D	
	BOES12L	12x34.5x24	AVAILABLE IN ALL STYLES
	BOES12R	12x34.5x24	

BASE CABINET SPECIFICATIONS GUIDE

BASE SPICE DRAWER CABINET	CODE	W X H X D	
	BSDC06	06x34.5x24	AVAILABLE IN ALL STYLES Note: Fitted drawers do not require nor include glides.

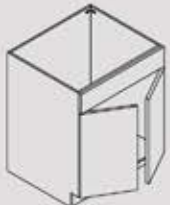
VANITY BASE SINK CABINET	CODE	W X H X D	
	VSB24	24x34.5x21	AVAILABLE IN ALL STYLES
	VSB30	30x34.5x21	

BASE END ANGLE CABINET	CODE	W X H X D	
	BEA12L	12x34.5x24	AVAILABLE IN ALL STYLES
	BEA12R	12x34.5x24	

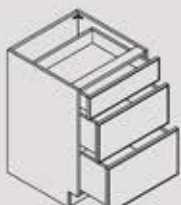
VANITY BASE SINK CABINET	CODE	W X H X D	
	VDB12-3	12x34.5x21	AVAILABLE IN ALL STYLES
	VDB15-3	15x34.5x21	
	VDB18-3	18x34.5x21	

2 DRAWER BASE CABINET*	CODE	W X H X D	
	DB24-2	24x34.5x24	AVAILABLE IN • IMPERIAL BLUE • SHAKER WHITE * Available Dallas location only.
	DB30-2	30x34.5x24	
	DB36-2	36x34.5x24	

TALL CABINET SPECIFICATIONS GUIDE

SINGLE DOOR PANTRY CABINET



CODE W × H × D

PC1884	18x84x24
PC1890	18x90x24
PC1896	18x96x24

AVAILABLE IN ALL STYLES

DOUBLE DOOR PANTRY CABINET

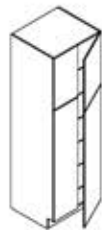

CODE W × H × D

PC2484	24x84x24
PC2490	24x90x24
PC2496	24x96x24
PC3084	30x84x24
PC3090	30x90x24
PC3096	30x96x24

AVAILABLE IN ALL STYLES

DOUBLE OVEN CABINET

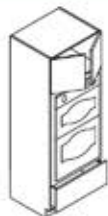

CODE W × H × D

DOC3084	30x84x24
DOC3090	30x90x24
DOC3096	30x96x24

AVAILABLE IN ALL STYLES

Note: DOC can be used for single oven. Ask Innovation Cabinetry for details.

Trim included for 27" appliance.

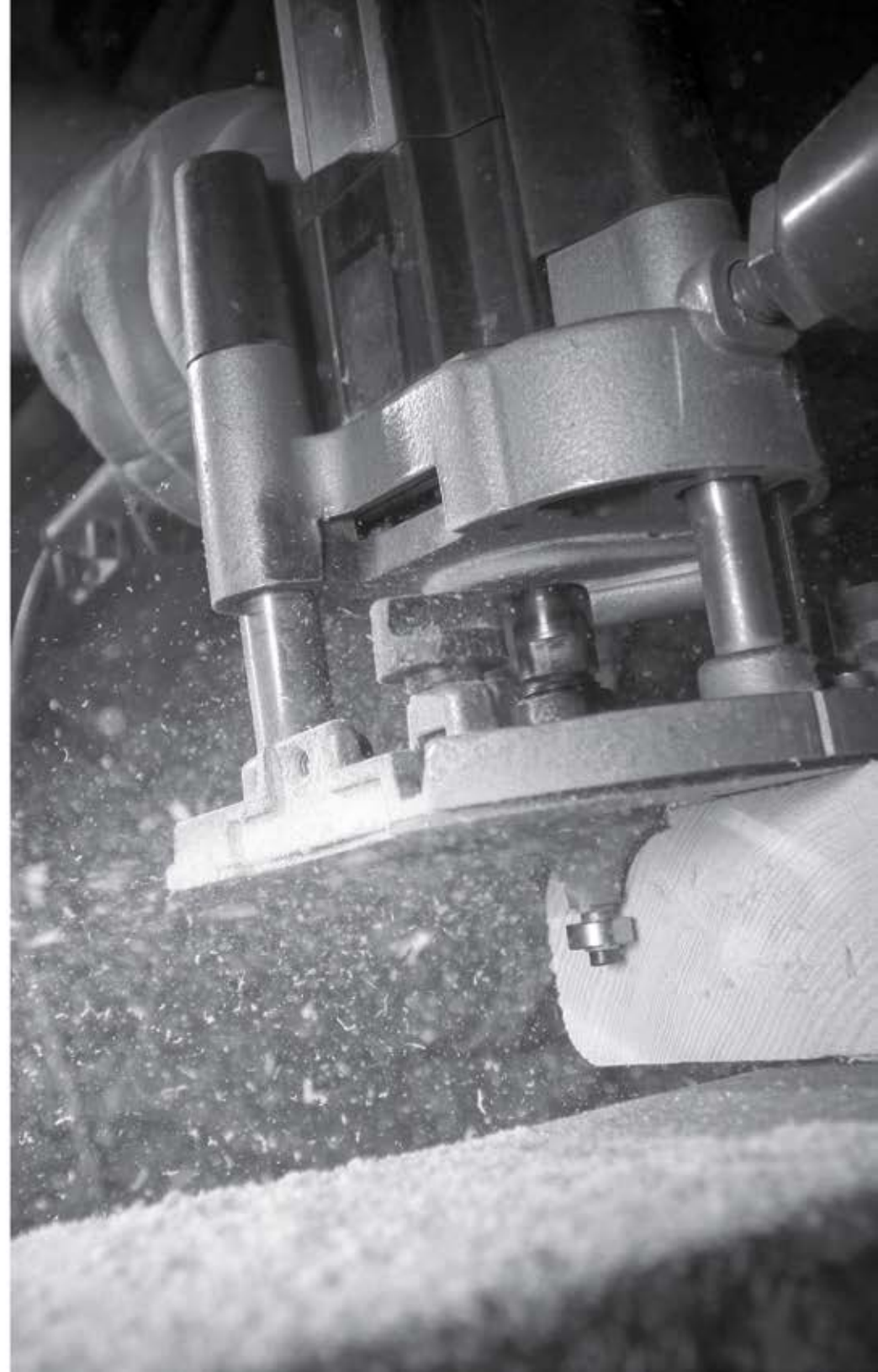

ACCESSORY & MOLDING SPECIFICATIONS GUIDE

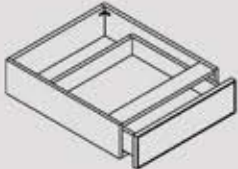
VANITY KNEE DRAWER	CODE	W X H X D	AVAILABLE IN ALL STYLES
	VKD24	24x07x21	
	VKD30	30x07x21	
	VKD36	36x07x21	

CABINET DOOR PANEL	CODE	W X H X D	AVAILABLE IN ALL STYLES
	D1230	12x30x.75	
	D1236	12x36x.75	
	D1242	12x42x.75	
	D1530	15x30x.75	
	D1536	15x36x.75	
	D1542	15x42x.75	
	D2430	24x30x.75	

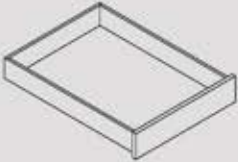
SOLID WOOD ROLL-OUT TRAY	CODE	W X H X D	NATURAL WOOD FINISH
	H-ROT15	15X4.125X20	
	H-ROT18	18X4.125X20	
	H-ROT21	21X4.125X20	
	H-ROT24	24X4.125X20	
	H-ROT27	27X4.125X20	
	H-ROT30	30X4.125X20	
	H-ROT33	33X4.125X20	
	H-ROT36	36X4.125X20	
	H-ROT39	39X4.125X20	

FINISHED PANEL	CODE	W X H X D	AVAILABLE IN ALL STYLES *DWPNL has toe-kick notch and no return.
	PNL2496	24x96x.75	
	PNL3596	35x96x.75	
	PNL4896	48x96x.75	
	DWPNL*	24x35x.75	

ACCESSORY & MOLDING SPECIFICATIONS GUIDE

SPINDLE LEG	CODE	W x H x D	
	SPOOL	03x36x03	AVAILABLE IN • COASTAL CREAM

SQUARE SPOOL	CODE	W x H x D	
	SQSPL3	4.5x34.5x4.5	AVAILABLE IN • CLASSIC WHITE • IMPERIAL BLUE • MADURO • PEARL WHITE • SHAKER WHITE • STORM GRAY

CORBEL	CODE	W x H x D	
	COR-42	3X6X3	AVAILABLE IN • COASTAL CREAM
	COR-58	4.25x12x4.25	

VALANCE	CODE	W x H x D	
	VAL36	36x4.5x.75	AVAILABLE IN • COASTAL CREAM
	VAL42	42x4.5x.75	
	VAL48	48x4.5x.75	
	VAL60	60x4.5x.75	

CORBEL - SQUARE	CODE	W x H x D	
	SQCOR3	4x12x4	AVAILABLE IN • CLASSIC WHITE • IMPERIAL BLUE • MADURO • PEARL WHITE • SHAKER WHITE • STORM GRAY

FILLER	CODE	W x H x D	
	WF330	03x30x.75	AVAILABLE IN ALL STYLES
	WF336	03x36x.75	
	WF342	03x42x.75	
	WF396	03x96x.75	
	WF630	06x30x.75	
	WF636	06x36x.75	
	WF642	06x42x.75	
WF696	06x96x.75		

ACCESSORY & MOLDING SPECIFICATIONS GUIDE

FLUTED FILLER	CODE	W X H X D	
	RWFC330	03x30x.75	AVAILABLE IN
	RWFC336	03x36x.75	<ul style="list-style-type: none"> • CLASSIC WHITE • COASTAL CREAM
	RWFC342	03x42x.75	<ul style="list-style-type: none"> • MADURO • PEARL WHITE
	RWFC396	03x96x.75	<ul style="list-style-type: none"> • SHAKER WHITE • STORM GRAY
			Note: Classic White, Imperial Blue, Maduro, Shaker White, Storm Gray with Plinth Block only

CLASSIC CROWN MOLDING	CODE	W X H X D	
	CCM8	2.375x3.25x96	AVAILABLE IN
			<ul style="list-style-type: none"> • CLASSIC WHITE • COASTAL CREAM • MADURO • SHAKER WHITE

ROSETTE APPLIQUE	CODE	W X H X D	
	RAFFB	03x03x.75	AVAILABLE IN
			<ul style="list-style-type: none"> • COASTAL CREAM
			Note: Applique has (3) raised ribs on back, intended to be used with RWFC Fluted Filler.

ANGLED CROWN MOLDING	CODE	W X H X D	
	ACM8	03x03x96	AVAILABLE IN
			<ul style="list-style-type: none"> • CLASSIC WHITE • IMPERIAL BLUE • MIDNIGHT ESPRESSO • PEARL WHITE • STORM GRAY • SHAKER WHITE

PLINTH BLOCK APPLIQUE	CODE	W X H X D	
	PBAFFB	03x04x.375	AVAILABLE IN
			<ul style="list-style-type: none"> • CLASSIC WHITE • COASTAL CREAM • IMPERIAL BLUE • MADURO • SHAKER WHITE • STORM GRAY
			Note: Applique has (3) raised ribs on back, intended to be used with RWFC Fluted Filler.

COVE MOLDING	CODE	W X H X D	
	CVM8	5x3.5x96	AVAILABLE IN
			<ul style="list-style-type: none"> • CLASSIC WHITE • IMPERIAL BLUE • PEARL WHITE • SHAKER WHITE • STORM GRAY

ACCESSORY & MOLDING SPECIFICATIONS GUIDE

COUNTER TOP MOLDING	CODE	W X H X D	AVAILABLE IN
	CTM8	02x.75x96	<ul style="list-style-type: none"> • CLASSIC WHITE • MIDNIGHT ESPRESSO • IMPERIAL BLUE • PEARL WHITE • SHAKER WHITE • STORM GRAY

OGEE MOLDING	CODE	W X H X D	AVAILABLE IN
	OGM8	02x.75x96	<ul style="list-style-type: none"> • CLASSIC WHITE • SHAKER WHITE • MADURO

TRIPLE BEAD MOLDING	CODE	W X H X D	AVAILABLE IN
	TBM8	02x.75x96	<ul style="list-style-type: none"> • COASTAL CREAM

LIGHT RAIL MOLDING	CODE	W X H X D	AVAILABLE IN
	IV18	.75x2x96	<ul style="list-style-type: none"> • CLASSIC WHITE • COASTAL CREAM • MADURO

OUTSIDE CORNER MOLDING	CODE	W X H X D	AVAILABLE IN ALL STYLES
	OCM8	.875x.875x96	

QUARTER ROUND MOLDING	CODE	W X H X D	AVAILABLE IN ALL STYLES
	QR8	.75x.75x96	

ACCESSORY & MOLDING SPECIFICATIONS GUIDE

BATTEN MOLDING	CODE	W X H X D	
	SMB	.75x.25x96	AVAILABLE IN ALL STYLES

SQUARE SCRIBE MOLDING	CODE	W X H X D	
	SQSM8	.25x.75x96	AVAILABLE IN ALL STYLES

TOE KICK MOLDING	CODE	W X H X D	
	TK8	.50x4.5x96	AVAILABLE IN ALL STYLES Note: Made of .5" plywood. Finished ends.

INSIDE CORNER TRIM	CODE	W X H X D	
	ICT8	.75x.75x96	AVAILABLE IN ALL STYLES

CABINET **DISCLAIMER**

Disclaimer for Painted Wood Cabinetry

Please be aware that wood expands and contracts. When this natural process occurs on painted cabinetry, it will create an open joint in the painted finish. An open joint line is not a defect, and it is known and accepted in the cabinet industry. The finish will still protect the surface, and the joint's structural integrity will not be affected. Every manufacturer of painted all-wood cabinets shares these issues. They are not unique to Innovation Cabinetry. Wood may expand and contract differently from cabinet to cabinet. Even joints within the same cabinet may behave differently. Some joined wood may not show any joint lines, others may be slightly visible, and others may display visible joint lines on day one of installation.

Joint lines also may occur due to the repeated impacts from regular, everyday use. To avoid damage to an exposed open wood joint due to water or heavy moisture exposure, remove any excess moisture from cabinet surfaces as soon as possible. Discolorations: All paints, especially lighter colors, are susceptible to discoloration due to airborne particles from cooking, grilling, tobacco smoke, fireplaces, or candles. Prolonged exposure to natural or artificial light may also alter the finish color.

Disclaimer for Stained Wood Cabinetry

All wood is a product of nature. While each wood type grows best in specific conditions, nature provides differences critical to the growth. As a result, soil and weather conditions will affect grain patterns and colors. The beauty of real wood is created by the infinite variation of grain, texture, and color.

This is especially true of hardwood and hardwood veneers. It is the nature of hardwoods to have mineral streaks and significant variation in graining. Colors range from light brown, dark brown and even black areas in the wood. Since the number of mineral lines varies from board to board, you may notice the difference between cabinets, doors, drawers, or even on the same panel. Mineral streaks or unusual graining are considered natural wood characteristics and will not be considered a defect or reason for replacement.

No particular emphasis is made to select materials to match each color. All color characteristics of the wood will change as it ages. This aging process will gradually change the color of the wood and the stain. The amount and rate of change will depend on many factors, including wood-type, stain color, and direct sunlight. Also, exposure to smoke, chemicals, and indoor lighting may cause some materials to vary from their original color over time. The softening color change is why cabinets or accessories added later may not match precisely to the previously installed cabinetry.

For this reason, door samples and displays may not be the same color as the cabinets you receive. Innovation Cabinetry cannot be responsible for the naturally occurring changes in your wood cabinets.



CABINET CLEANING AND CARE GUIDELINES

General Care

A soft cotton or microfiber cloth dampened with warm water is usually sufficient to clean your cabinets. If more thorough cleaning is required, use one of the following cleaning solutions:

- A fresh solution of mild dishwashing liquid mixed with warm water.
- A mild all-purpose cleaner that does not contain ammonia or silicone.

Use the mildest cleaning solution that will successfully clean your cabinets. Stronger products may damage or discolor your cabinet finish, may void your warranty, and are not recommended. After cleaning, wipe all surfaces with a clean, damp cotton cloth. Dry immediately, using another clean/ dry cotton cloth.

Cleaning Products to Avoid

Avoid using the following cleaning products on your cabinets:

- Harsh chemicals.
- Abrasive cleaning products such as; tub/ sink cleansers, scouring powder, scouring pads, or steel wool.
- Sponges or dish clothes. (They may contain particles that could scratch your cabinets, or they may contain staining food or oil residue.)
- Ammonia or ammonia-based cleaning products.
- Bleach or bleach-based cleaning products.
- Silicone-based cleaning, waxing, or polishing products.

Spatters and Spills

Clean spills and splatters immediately. Prolonged exposure to spills, including food, water, or other liquids, or to oil and grease splatters can cause permanent discoloration or damage to your cabinet's finish.

Waxing and Polishing

Waxing is not recommended. Over time, waxing and polishing compounds may build up on the surface of your cabinet causing a hazy, streaky or yellowed appearance to your cabinet's finish.

Cleaning Glass Doors

Extra care is required when cleaning glass doors. Spray an ammonia-free glass cleaner on a clean cotton cloth or paper towel. Do not spray cleaner directly on the glass. The spray could run or seep behind the frame or mullions and cause damage.

Scratches, Gouges and Nicks

A Touch-Up Kit is available to hide surface damage. Contact Innovation Cabinetry to purchase the color-matched touch-up kit for your specific cabinets. Use the kit's touch-up pen to hide minor blemishes. Use the kit's tinted putty to fill deeper scratches, gouges, or nicks. Detailed instructions are provided in each kit.

Regular Dusting

Use a clean/ dry soft cotton cloth for regular dusting. Packaged dusting sheets are not recommended. Do not use pre-moistened dusting sheets, or aerosol products made for dusting.

Avoid Moisture Damage

Avoid draping damp clothes or dish clothes over cabinet doors. This moisture can cause permanent damage: including but not limited to peeling and discoloration of the cabinet's finish.

Avoid Light Damage

Exposure to direct sunlight tends to darken the color of natural wood products. Sunlight can also fade painted wood surfaces. Consider the use of draperies or blinds to protect your cabinets from direct sunlight.

Avoid Heat Damage

The heat generated when using an oven's self-cleaning feature is much greater than during normal cooking. If this heat escapes from the oven, it can damage your cabinets. While this is a rare circumstance, you can minimize the risk of cabinet damage by removing cabinet door and drawers nearest the oven before using its self-cleaning feature.

POLICIES AND GENERAL INFO

RETURN POLICY

Returns or exchanges must be made within 45 days from the sales order/invoice date, accompanied by a valid Innovation Cabinetry sales order/invoice. Innovation Cabinetry must inspect returns or exchanges before its acceptance for return.

Cabinets must be returned in their unopened, original boxes. Boxes cannot be wet or damaged and must be free of dirt, paint, markers, etc. All hardware must be in its original packing. Hardware must be free from scratches, dirt, paint, markers, etc.

Customized or assembled cabinets cannot be returned under any circumstance. Products damaged in transit shipped by F.O.B. Innovation's warehouse through a freight company cannot be returned to Innovation.* Innovation Cabinetry reserves all rights to refuse to accept any item for return or refund.

* Note: To claim loss and damage in transit of products shipped by F.O.B. please refer to Innovation's Transportation Policy and the freight company's claim procedures.



TEN YEAR LIMITED WARRANTY ON CABINETS

Innovation Cabinetry, LLC warrants to the original residential end-user that cabinetry and all hardware products shall be free from defects in material and workmanship under everyday use for ten (10) years from the date of shipment. This Warranty is only applicable to products used in residential applications within the United States and is nontransferable to subsequent end-users or owners. Should defects in material exist or occur during the warranty period, Innovation Cabinetry, LLC, at its sole discretion, will either (1) repair or replace the defective component free of charge or (2) refund the purchase price of the defective component. This Warranty covers only materials and components of products supplied by Innovation Cabinetry, LLC. This Warranty does not cover costs or labor to remove and reinstall countertops, appliances, plumbing fixtures, electrical outlets, etc. This Warranty shall become void if the cabinets are in any way modified, improperly installed, or damaged before or during the installation process. This Warranty shall become void if products utilized in any application other than the common uses for residential cabinetry. Furthermore, this Warranty will not apply to cabinets damaged by misuse, neglect, abuse, acts of God, exposure to moisture, exposure to extreme temperatures, or the effects of normal wear and tear. Natural woods vary in color and characteristics and will exhibit subtle changes as they age. Sunlight, smoke, household cleaners, and other environmental conditions may also affect the color over time. Color and wood characteristics are considered the nature of the material related to their environment and exposures and not covered under this Warranty. Innovation Cabinetry, LLC reserves the right to alter design, specifications, and material without obligation to make similar changes to products previously manufactured. The repair(s) or replacement(s) is contingent upon the current product offering of style and construction within the Innovation Cabinetry, LLC product line at the time of the Warranty claim. If a warranty claim is filed after a product becomes obsolete, Innovation Cabinetry, LLC reserves the right to honor the Warranty in one of the following fashions:

- To replace the affected component with a new component of the same style.
- To replace the affected component and any other component(s) in the residential application to achieve a reasonably uniform appearance with a similar and comparable product style of the originally purchased style.

- Refund the purchase price of the defective component. Innovation Cabinetry, LLC cannot guarantee that these replacements will match the original components' finish and appearance in the residential application. This is due to natural variations and the changes that occur during the woods' natural aging process, affecting its color and grain.

THE LIMITED WARRANTY IS THE EXCLUSIVE WARRANTY OF INNOVATION CABINETRY, LLC. THIS LIMITED WARRANTY IS EXTENDED IN LIEU OF AND TO THE EXCLUSION OF ALL OTHER WARRANTIES, EXPRESS, IMPLIED, OR STATUTORY, INCLUDING ANY IMPLIED WARRANTY OF MERCHANTABILITY OR FITNESS FOR A PARTICULAR PURPOSE. IN NO EVENT SHALL INNOVATION CABINETRY, LLC'S LIABILITY EXCEED THE BUYER'S PURCHASE PRICE. THE LIMITED WARRANTY RUNS ONLY TO THE ORIGINAL END-USER OF THE PRODUCTS. THE LIMITED WARRANTY IS NOT INTENDED TO, AND DOES NOT, RUN TO ANY SUBSEQUENT BUYER OR END-USER, NOR TRANSFERRED TO ANY OTHER PERSON, UNLESS OTHERWISE SPECIFICALLY STATED IN WRITING BY AN OFFICER OF INNOVATION CABINETRY, LLC. IN NO EVENT SHALL INNOVATION CABINETRY, LLC BE LIABLE TO THE END-USER OR ANY THIRD PARTY FOR SPECIAL, COLLATERAL, INCIDENTAL, CONSEQUENTIAL, OR PUNITIVE DAMAGES.

This Warranty gives you specific legal rights, and you may have other rights, which vary from state to state. Some states do not exclude or limit incidental or consequential damages, so the above limitations or exclusions may not apply. To make a warranty claim, you must first contact your authorized Innovation Cabinetry, LLC dealer, contractor, or distributor, who will arrange for an inspection of the cabinetry products. Innovation Cabinetry, LLC must verify the date of purchase and products purchased to extend the Warranty's benefits. It is highly recommended you retain receipts for product purchases. Thank you for your purchase of Innovation Cabinetry, LLC's high-quality cabinetry products! We trust that our products will bring you many years of outstanding service and appearance.

GET **SOCIAL** WITH US!

Follow Innovation Cabinetry on Facebook and Instagram for design inspiration and tips to make your space both functional and beautiful!





INNOVATION CABINETS

INNOVATION CABINETS HEADQUARTERS - TAMPA

7030 Anderson Road | Tampa, Florida 33634
727-535-7667 | 888-206-1088 | fax 813-884-0007 | info@innovationcabinets.com

INNOVATION CABINETS - DALLAS

11925 N Stemmons FWY, Ste 190 | Dallas, Texas 75234
214-380-3660 | 888-290-9770 | fax 214-380-3661 | dallas@innovationcabinets.com

GET SOCIAL WITH US:



Member
NKBA